

The Richelieu logo is displayed in a bold, red, sans-serif font. The background of the entire page is a collage of various wooden cabinet door and frame samples, including a large, detailed view of a multi-layered frame in the upper right, several smaller inset images of different door styles in the center, and a curved door and chair back in the lower left, and another frame detail in the lower right.

**CABINET DOORS
GENERAL PROGRAM**

www.richelieu.com

More than 10,000 Available Models

Table of contents

| | |
|----------------------------------|-------------|
| General Information _____ | pages 2-3 |
| A, M Frames _____ | pages 4-5 |
| A, B, E and F Frames _____ | pages 6-7 |
| A, B, E, G and N Frames _____ | pages 8-9 |
| C, D, G, H, J and M Frames _____ | pages 10-11 |
| Glass and Special Doors _____ | pages 12-13 |
| Curved Doors _____ | pages 14-15 |
| Decorative Metal Doors _____ | page 16 |

DB2007E

PROFILES AND PANELS

Available frame profiles with tenon assembly only

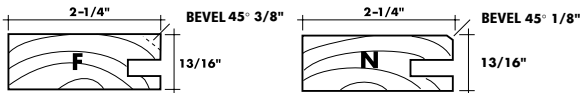

Available frame profiles with tenon or 45° assembly

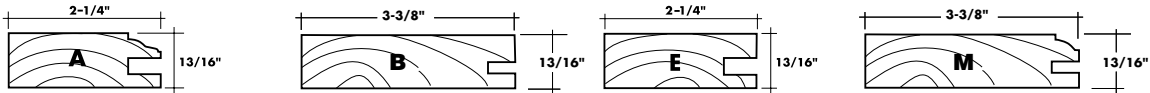

Available frame profiles with 45° assembly only

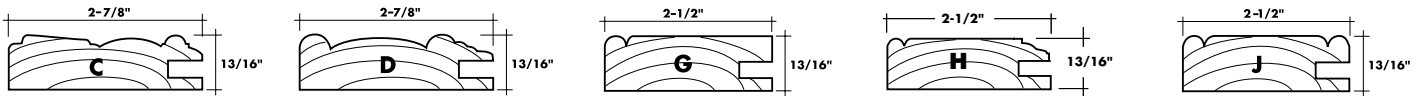

Panel profiles

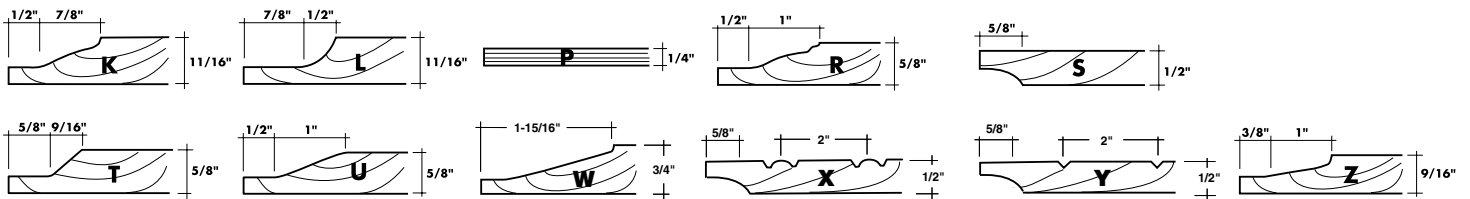
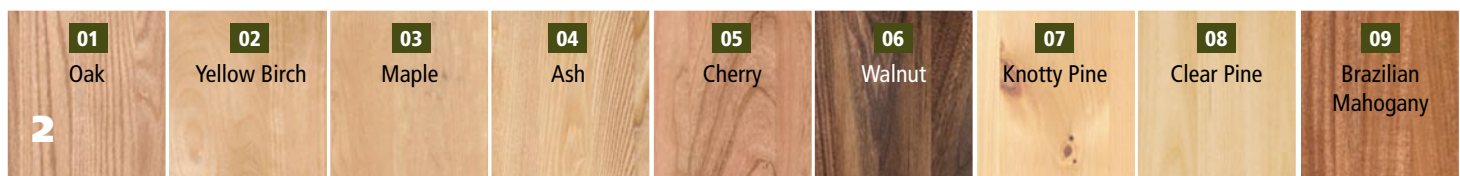

TABLE OF AVAILABLE CONFIGURATIONS

| Assembly | Model | Frame | Contour | Panel | Species | Door Type | Curved Doors |
|----------|---------------|-------|---------|----------------------------------|------------------------|-----------------|--------------|
| tenon | 110, 113, 115 | A | yes | K, L, P*, R, S, T, U, X, Y, Z | all | all | yes |
| | 300, 301, 302 | A | | K | all | all | yes |
| tenon | 112 | B | yes | K, L, P*, R, S, T, U, W, X, Y, Z | all | all | no |
| tenon | 100, 114 | E | yes | K, L, P*, R, S, T, U, X, Y, Z | all | all | yes |
| | 101, 102 | E | yes | P only | 01, 02, 03 | frame door only | no |
| | 107, 108 | E | yes | S only | 01, 02, 03, 05, 07, 08 | frame door only | no |
| | 103, 104 | E | yes | P only | 01, 03 | frame door only | no |
| tenon | 109 | F | yes | K, L, P*, R, S, T, U, X, Y, Z | all | all | yes |
| tenon | 117 | M | yes | S, W | 01, 02, 03, 05 | all | no |
| tenon | 111 | N | yes | K, L, P*, R, S, T, U, X, Y, Z | all | all | no |
| 45° | 500 | A | yes | K, L, P*, R, S, T, U, X, Y, Z | all | all | no |
| 45° | 535 | B | yes | K, L, P*, R, S, T, U, W, X, Y, Z | all | all | no |
| 45° | 501 | C | no | K, L, P, R, S, T, U, X, Y, Z | 01, 03, 04, 05 | all | no |
| 45° | 502 | D | no | K, L, P, R, S, T, U, X, Y, Z | 01, 02, 03, 04, 05 | all | no |
| 45° | 514 | E | yes | K, L, P*, R, S, T, U, X, Y, Z | all | all | no |
| | 515, 516, | E | yes | P only | 01, 02, 03 | frame door only | no |
| | 517, 518 | E | yes | S only | 01, 02, 03, 05, 07, 08 | frame door only | no |
| | 519, 520 | E | yes | P only | 01, 03 | frame door only | no |
| 45° | 503 | G | no | K, L, P, R, S, T, U, X, Y, Z | 01, 03 | all | no |
| | 504, 505 | G | no | P only | 01, 03 | frame door only | no |
| | 510, 511 | G | no | S only | 01, 03 | frame door only | no |
| | 506, 507 | G | no | P only | 01, 03 | frame door only | no |
| 45° | 513 | H | no | K, L, P, R, S, T, U, X, Y, Z | 01, 03 | all | no |
| 45° | 512 | J | no | K, L, P, R, S, T, U, X, Y, Z | 01, 03 | all | no |
| 45° | 521 | M | yes | S, W | 01, 02, 03, 05 | all | no |

*P panels are only available in Species 01, 02, 03, 04, and 09

AVAILABLE SPECIES



DRAWER FRONTS

Drawer fronts can be made of a solid piece of wood without a frame, in that case, only the front contour can be machined. See below. Fronts can also be coordinated with the door model: same frame, same panel, same assembly. In that case, 4 front types are available.

Solid Front



Type 010

Solid front
Horizontal Grain

Tenon Assembly



Type 11

Narrow top & bottom rail
Horizontal Grain



Type 11

Narrow top & bottom rail
Vertical Grain



Type 13

Standard frame
Horizontal Grain



Type 13

Standard frame
Vertical Grain

45° Assembly



Type 14

Narrow frames all around
Horizontal Grain



Type 14

Narrow frames all around
Vertical Grain



Type 13

Standard frames all around
Horizontal Grain



Type 13

Standard frames all around
Vertical Grain

CONTOUR MACHINING OPTIONS

These options are available for all square contour profiles, such as A, B, E, F, M, and N.



Contour A



Contour B



Contour C



Contour D



Contour F



Contour H



Contour K



Contour L



Contour M



Contour R



Contour U



Contour W

**Create your own door models and order them
direct via our web site, at www.richelieu.com.
It's easy and accurate!**

Richelieu

CABINET DOORS "A" FRAME

www.richelieu.com



| Reference | Model | Frame | Contour | Panel | Assembly | Species |
|-----------|-------|-------|---------|-------|----------|--------------|
| 1 | 110 | A | A | K | tenon | knotty pine |
| 2 | 110 | A | B | P | tenon | oak |
| 3 | 110 | A | A | K | tenon | oak |
| 4 | 110 | A | A | T | tenon | ash |
| 5 | 301 | A | A | K | tenon | mahogany |
| 6 | 300 | A | B | K | tenon | maple |
| 7 | 302 | A | A | P | tenon | yellow birch |
| 8 | 110 | A | A | U | tenon | cherry |

MAIN MODELS, A AND M FRAMES, TENON ASSEMBLY, VARIOUS PANELS



110-AK



110-AX



110-AR



110-AW



110-AL



117-MW

Model
Panel
Frame

FRAME PROFILES

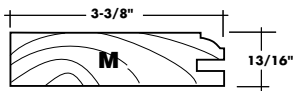
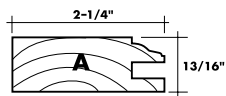

300-AK



301-AK



302-AK



115-AL



115-AK



113-AK



113-AZ

COLOUR CODES

GLASS DOOR AVAILABLE

CURVED DOOR AVAILABLE

45° ASSEMBLY AVAILABLE

All our models based on frames A or M are available with a fabricated outside contour. See our contour options on Page 3.

MAIN MODELS, A AND M FRAMES, 45° ASSEMBLY, VARIOUS PANELS



500-AZ



500-AT



500-AY



521-MW

All our models with frame "A", can be combined to all our panels.
Any door higher than 49 1/4 inch will be made with a central rail.

Richelieu

CABINET DOORS

A, B, E and F FRAMES

www.richelieu.com



| Reference | Model | Frame | Contour | Panel | Assembly | Species |
|-----------|-------|-------|---------|-------|----------|------------|
| 1 | 100 | E | A | S | tenon | maple |
| 2 | 115 | A | A | K | tenon | oak |
| 3 | 109 | F | A | S | tenon | clear pine |
| 4 | 100 | E | A | P | tenon | oak |
| 5 | 113 | A | A | K | tenon | oak |
| 6 | 113 | A | A | R | tenon | walnut |
| 7 | 115 | A | A | T | tenon | maple |
| 8 | 109 | F | A | Z | tenon | cherry |

MAIN MODELS, B, E, F AND N FRAMES, TENON ASSEMBLY, VARIOUS PANELS



100-ER



100-ET



100-EU

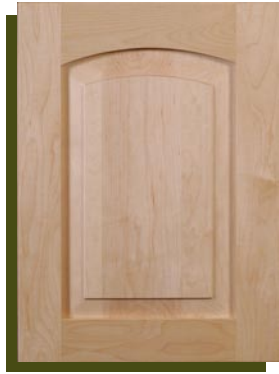

114-EZ



114-ES



100-ES

COLOUR CODES

GLASS DOOR AVAILABLE

CURVED DOOR AVAILABLE

45° ASSEMBLY AVAILABLE

All our models based on frames B, E, F or N are available with a fabricated outside contour. See our contour options on page 3.

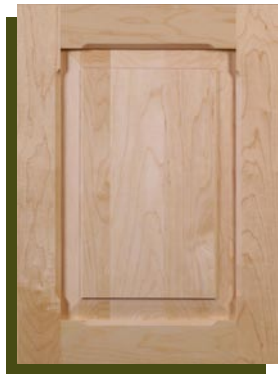

109-FZ



109-FT



109-FS



111-NX



111-NU



111-NS

FRAME PROFILES

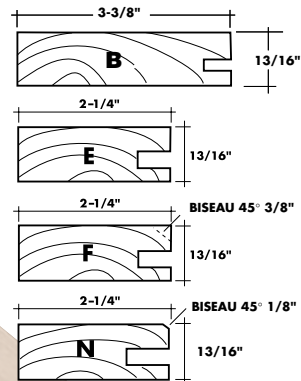

112-BS

Model Frame Panel

MAIN MODELS, B AND E FRAME, 45° ASSEMBLY, VARIOUS PANELS



514-EL



514-EW



514-EY

Our models with frame B, E, F or N can be combined to all our panels.

Any door higher than 49 1/4 inch will be made with a central rail.



535-BS

Richelieu

CABINET DOORS

A, E FRAMES and N

www.richelieu.com



| Reference | Model | Frame | Contour | Panel | Assembly | Species |
|-----------|-------|-------|---------|-------|----------|-------------|
| 1 | 111 | N | A | S | tenon | knotty pine |
| 2 | 114 | E | A | S | tenon | maple |
| 3 | 519 | E | A | P | 45° | maple |
| 4 | 100 | E | A | S | tenon | maple |
| 5 | 110 | A | B | U | tenon | maple |
| 6 | 107 | E | A | S | tenon | maple |
| 7 | 516 | E | A | P | 45° | maple |
| 8 | 111 | N | A | Y | tenon | oak |

MAIN MODELS, E FRAME, TENON ASSEMBLY, PANELS «P» OR «S» WITH MOULDINGS

COLOUR CODES

GLASS DOOR AVAILABLE

CURVED DOOR AVAILABLE

45° ASSEMBLY AVAILABLE

All our models from frame E are available with a fabricated outside contour. See our contour options on Page 3.

The use of a P panel (1/4" plywood) cannot guarantee the door stability.



107-ES

101-EP



108-ES

102-EP



103-EP (3/8" rope moulding)



104-EP (5/8" rope moulding)

MAIN MODELS, E FRAME, 45° ASSEMBLY, P OR S PANELS WITH MOULDINGS



514-ES



517-ES

515-EP



518-ES

516-EP



519-EP (3/8" rope moulding)



520-EP (5/8" rope moulding)

MAIN MODELS, G FRAME, 45° ASSEMBLY, P OR S PANELS WITH MOULDINGS

FRAMES

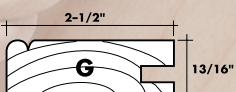
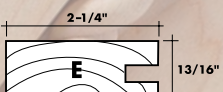
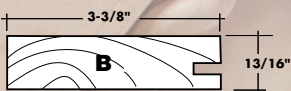

510-GS

504-GP



511-GS

505-GP

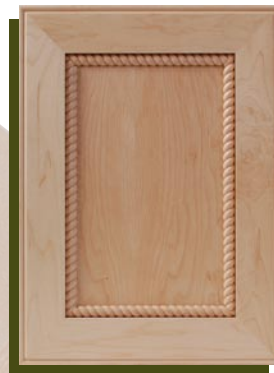

506-GP (3/8" rope moulding)



507-GP (5/8" rope moulding)

NOTES RELATED TO FLAT-PANEL DOORS WITH SUPERIMPOSED MOULDINGS OR ROPE MOULDINGS

- These door models can allow a single-pane glass panel only (type 01).
- Models with S panels and surface-mounted rope mouldings are available only in the following species: oak (01), yellow birch (02), maple (03), cherry (05), knotty pine (07) and clear pine (08)
- Models with P panels and surface-mounted rope mouldings are available only in the following species: oak (01), yellow birch (02) and maple (03).
- Models with rope mouldings can only be done on P panels and are available only in the following species: oak (01) and maple (03).

Richelieu

CABINET DOORS

C, D, G, H, J FRAMES & M

www.richelieu.com



| Reference | Model | Frame | Contour | Panel | Assembly | Species |
|-----------|-------|-------|---------|-------|----------|---------|
| 1 | 511 | G | - | S | 45° | maple |
| 2 | 501 | C | - | K | 45° | ash |
| 3 | 512 | J | - | T | 45° | maple |
| 4 | 501 | C | - | K | 45° | oak |
| 5 | 502 | D | - | R | 45° | maple |
| 6 | 505 | G | - | P | 45° | oak |
| 7 | 521 | M | - | W | 45° | maple |
| 8 | 501 | C | - | R | 45° | cherry |

MAIN MODELS, C, D, G, H, J AND M FRAMES, 45° ASSEMBLY, CHOICE OF PANELS



501-CR



501-CX



501-CT



501-CW



501-CZ



502-DR



502-DU



502-DK



502-DW



513-HR



513-HT



513-HU



521-MW



512-JK



512-JL



503-GR



503-GT



503-GW

COLOUR CODES

GLASS DOOR AVAILABLE

CURVED DOOR AVAILABLE

45° ASSEMBLY AVAILABLE

FRAMES

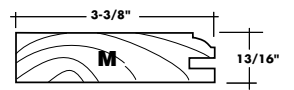
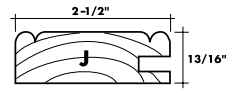
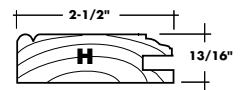
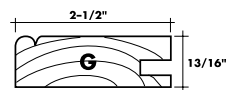
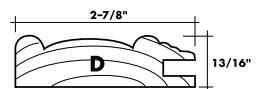
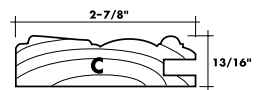

All mitered doors with 45° assembly cannot be curved.

Richelieu

CABINET DOORS SPECIAL DOORS

www.richelieu.com



| Reference | Description | Type | Model | Frame | Contour | Panel | Assembly | Species |
|-----------|-------------------------|------|-------|-------|---------|-------|----------|---------|
| 1 | left china cabinet door | 1210 | 110 | A | A | - | tenon | maple |
| 2 | 4 equal panes | 24 | 110 | A | A | - | tenon | ash |
| 3 | 6 equal panes | 26 | 115 | A | B | - | tenon | cherry |
| 4 | 6 equal panes | 26 | 502 | D | - | - | 45° | cherry |
| 5 | with horizontal rail | - | 302 | A | B | K | tenon | oak |
| 6 | with vertical rail | - | 100 | E | A | S | tenon | maple |

AVAILABLE DOOR TYPES IN MOST OF OUR MODELS

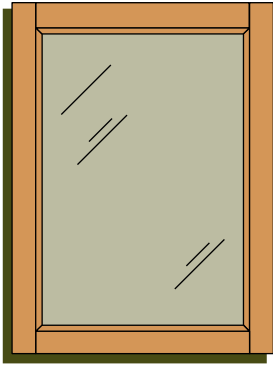

1 TYPE 20

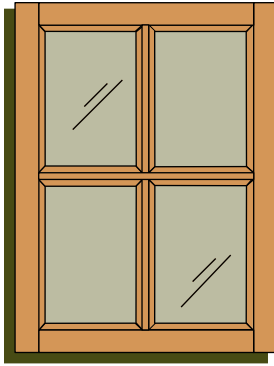

2 TYPE 24

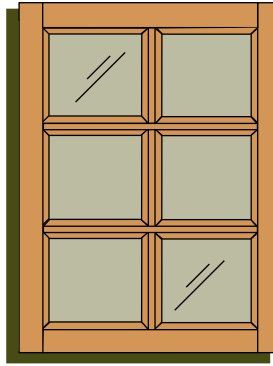

3 TYPE 26

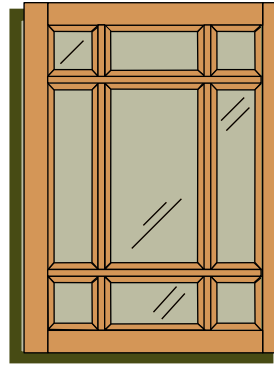

4 TYPE 29

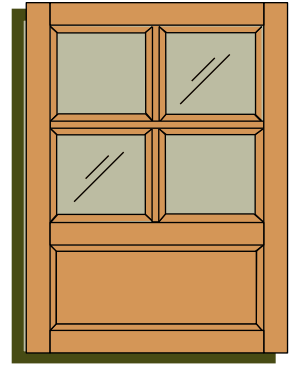

5 TYPE 27

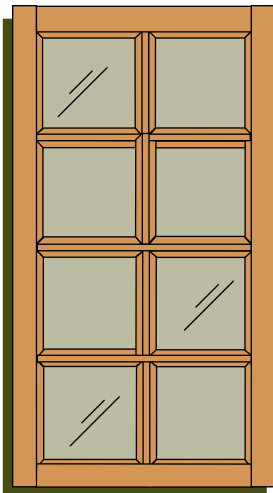

6 TYPE 28

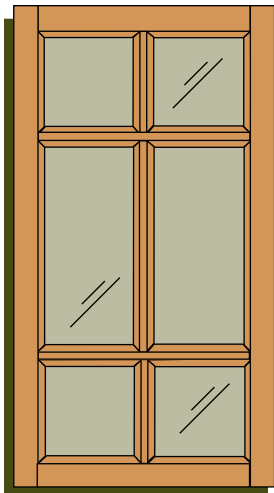

7 TYPE 23

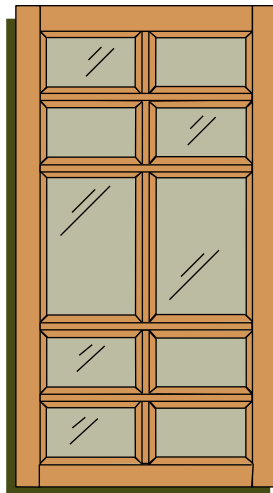

8 TYPE 25

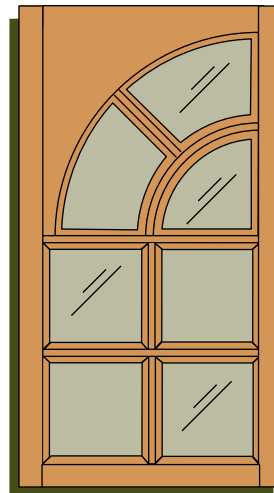

9 TYPE 1210

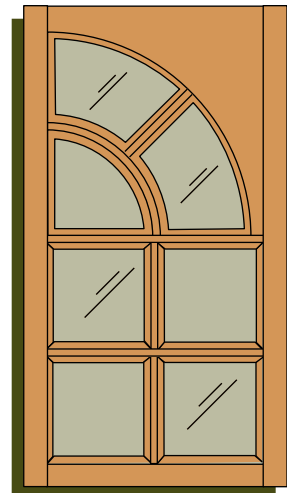

10 TYPE 1220

IMPORTANT: for door models made with B, E, F, G, J, and N frames, mullions are not integral to the door and must be glued to the glass surface.

| Ref. | Door Type | Notes |
|------|----------------------|--|
| 1 | frame door | Available for all frames, assemblies and models |
| 2 | 4 equal panes | Not available on models with surface-mounted mouldings or added rope mouldings |
| 3 | 6 equal panes | Not available on models with surface-mounted mouldings or added rope mouldings |
| 4 | 9 panes | Not available on models with surface-mounted mouldings or added rope mouldings |
| 5 | 4 panes + panel | Not available on models with surface-mounted mouldings or added rope mouldings |
| 6 | 8 equal panes | Not available on models with surface-mounted mouldings or added rope mouldings |
| 7 | 6 panes | Not available on models with surface-mounted mouldings or added rope mouldings |
| 8 | 10 panes | Not available on models with surface-mounted mouldings or added rope mouldings |
| 9 | left sideboard door | Available with A frame only, in widths of 13-3/8", 14-7/8", 16-3/8", and 17-7/8" |
| 10 | right sideboard door | Available with A frame only, in widths of 13-3/8", 14-7/8", 16-3/8", and 17-7/8" |

- Glass door heads are as per the selected model. If a rounded head model is chosen (i.e. 113 or 114) the head of the glass door will also be curved as per the selected model.
- Our glass doors are fabricated to receive a single pane glass. For our special crown models (114, 300, etc.), we can fabricate the door to receive a square glass pane. Tell us what you need.
- Several other types of special doors, such as doors with vertical or horizontal frame members or panels for appliance fronts are also available through special order. Please contact us.

Richelieu

CABINET DOORS

A, E FRAMES and N

www.richelieu.com



| Reference | Product Description | Model | Frame | Contour | Panel | Species |
|-----------|--|--------|-------|---------|---------------|---------|
| 1 | R12" light valence (1/4 circle) | 166 RX | - | - | - | maple |
| 2 | R12" convex door (1/4 circle) | 302 | A | B | K | cherry |
| 3 | R12" concave crown moulding (1/4 circle) | 165 RV | - | - | - | oak |
| 4 | R12" concave door (1/4 circle) | 110 | A | A | K | maple |
| 5 | R12" convex door (1/4 circle) | 110 | A | A | 6 equal panes | oak |
| 6 | R12" convex door (1/4 circle) | 110 | A | A | K | maple |
| 7 | R12" kick plate | 167 RX | - | - | - | maple |
| 8 | R18" convex crown moulding (1/8 circle) | 165 RX | - | - | - | oak |
| 9 | R18" convex door (1/8 circle) | 301 | A | A | K | oak |

CURVED DOORS

Available Radii

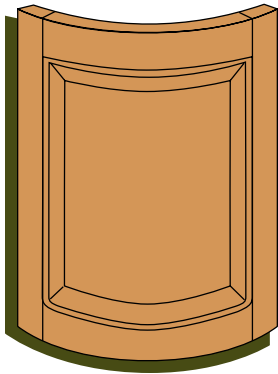

R12" CONVEX

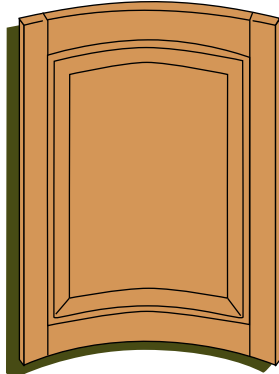

R12" CONCAVE

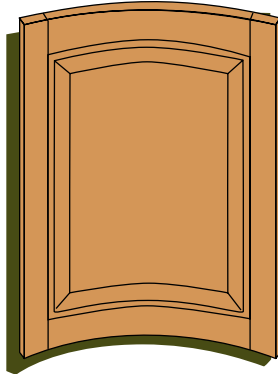

R18" CONCAVE and R24"

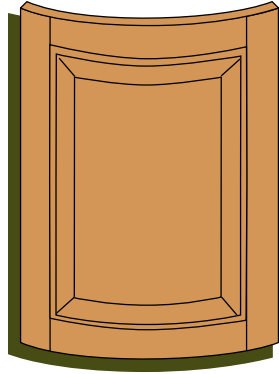

R18" AND R24" CONVEX

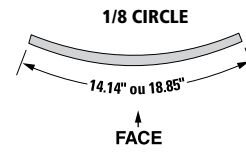
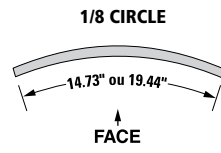
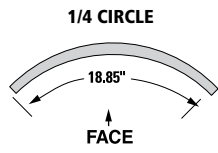
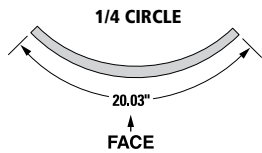

Cabinet Dimensions

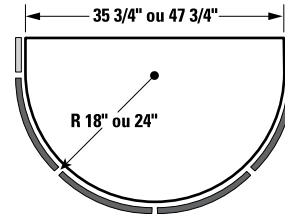
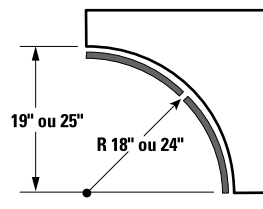
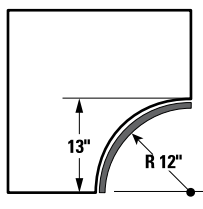
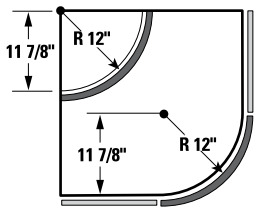

Curved Door Examples

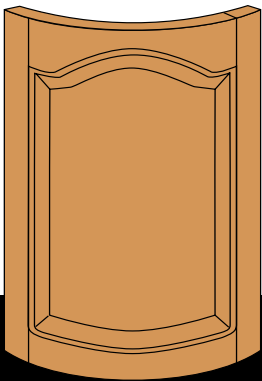

DOOR MODEL 113

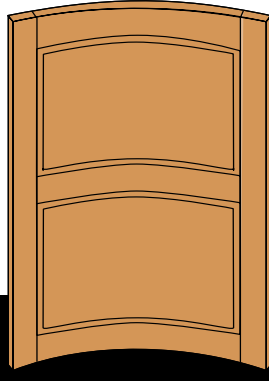

WITH HORIZONTAL RAIL

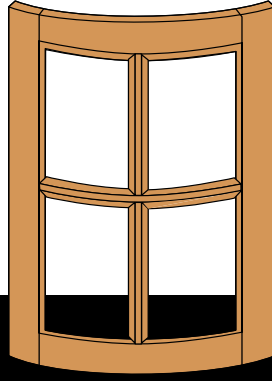

4 GLASS PANES

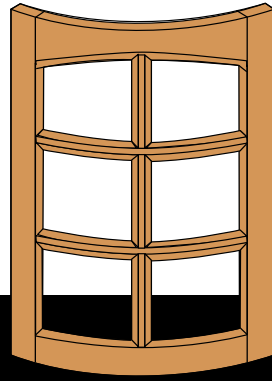

6 GLASS PANES

RELATED PRODUCTS



CROWN MOULDING



KICK PLATE



LIGHT VALENCE

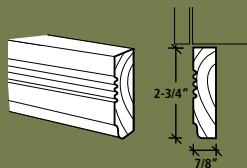

There is a size of related product for each of the available curved doors.

NOTE

Our curved doors are only available on models with tenon assembly, and only in the specified radii shown on this page.

Only A, E, F, and N frames may be used for their fabrication.

Glass insert doors made from these frames are also available in curved versions.

Door models that include mouldings and surface-mounted rope mouldings cannot be curved.

For our curved doors, available species are oak (01), yellow birch (02), maple (03) and cherry (05). Some other species are available by special demand.

We suggest that you have your doors available before you start fabricating your cabinets.

Richelieu

CABINET DOORS DECORATIVE METAL

www.richelieu.com

In your framed doors, you can insert these magnificent decorative metal centres. With a thickness of 3/16" (4,75 mm) they are custom-built. Offered in four finishes and four models, they can certainly bring an added touch to all your projects.



1



2



3

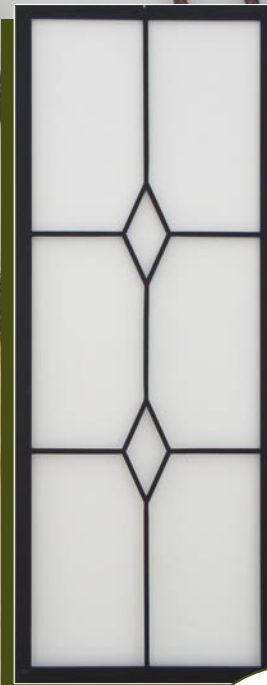

4

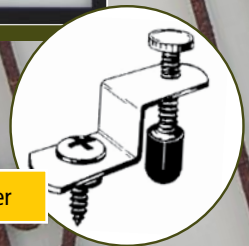

Rear brackets are included with your order

| Reference | Model | Finish | Available Finishes | Required Overall Dimensions for Fabrication |
|-----------|-------|--------|-----------------------------|---|
| 1 | F03 | rust | silver, bronze, black, rust | Width: 8-3/16" to 16-3/16" height: 19-3/16" to 45-3/16" |
| 2 | F02 | bronze | silver, bronze, black, rust | Width: 8-3/16" to 16-3/16" height: 19-3/16" to 45-3/16" |
| 3 | F01 | silver | silver, bronze, black, rust | Width: 8-3/16" to 16-3/16" height: 19-3/16" to 45-3/16" |
| 4 | F04 | black | silver, bronze, black, rust | Width: 8-3/16" to 16-3/16" height: 19-3/16" to 45-3/16" |

Richelieu

**TO CREATE AND ORDER YOUR OWN DOOR MODELS
GO TO OUR WEBSITE**

www.richelieu.com

IT'S QUICK, EASY AND ACCURATE.

FROM OUR WEBSITE www.richelieu.com, PROCEED AS FOLLOW:

- 1- Identify the product category that interests you.
- 2- Choose from our bestsellers or create your own model.
- 3- If you are creating your own model, please indicate the type of assembly (tenon or 45°).
- 4- Then, choose your frame.
- 5- Choose your desired model.
- 6- Do you prefer a frame door or a panel door?
- 7- If it's a panel door, select your panel.
- 8- Indicate the wood species to be used in your door.
- 9- Then, choose the outside contour.
- 10- What wood category do you want?
- 11- Indicate the door dimensions.

THIS STEP-BY-STEP METHOD MAY ALSO BE USED TO CREATE AND ORDER DRAWER FRONTS, GLASS DOORS, CURVED DOORS, ALUMINUM OR STAINLESS STEEL DOORS AS WELL AS EXCELSIUS DOORS.

BY PLACING YOUR ORDER ONLINE

- **You can place an order and obtain a quote 24 hours a day.**
- **You can follow up on your order.**
- **Upon shipment, you will receive an e-mail notice from the shipper that contains all details of your order.**
- **Technical support is available at these numbers: 450 687-9199 / 1 866 979-5999**
- **You can assist your customers with the product design.**