



4700



4706



4709



Tiroir/Drawer 4700

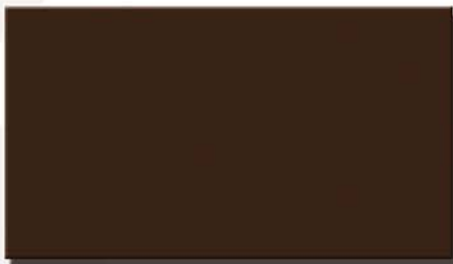

Tiroir/Drawer 4706

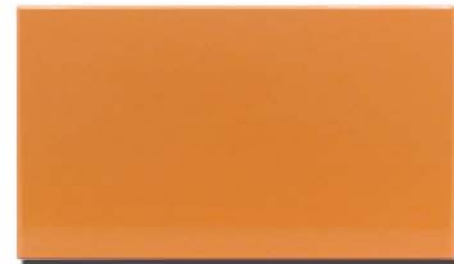

Tiroir/Drawer 4709

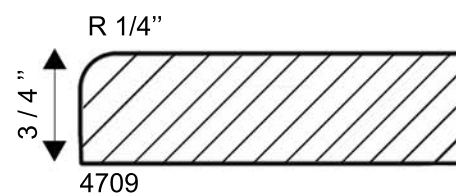
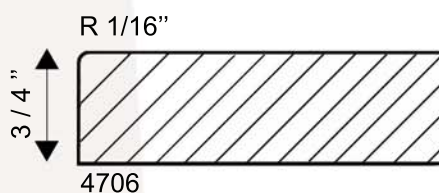
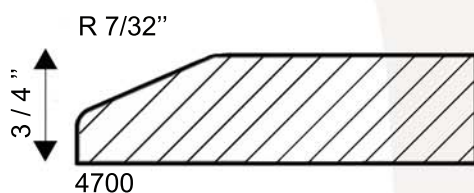

Modèle/Model	4700	4706	4709	4700 Tiroir/Drawer	4706 Tiroir/Drawer	4709 Tiroir/Drawer
H / H Min.	3" / 76mm	3" / 76mm	3" / 76mm	3" / 76mm	3" / 76mm	3" / 76mm
L / W Min.	3" / 76mm	3" / 76mm	3" / 76mm	3" / 76mm	3" / 76mm	3" / 76mm



4710



4711



4720



Tiroir/Drawer 4710



Tiroir/Drawer 4711



Tiroir/Drawer 4720

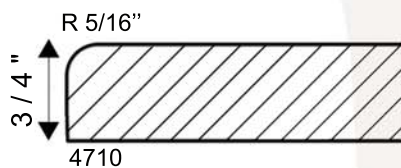

4710

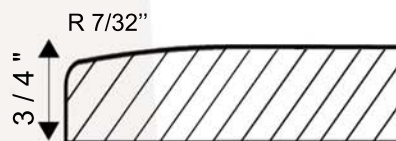

4711



4720

Modèle/Model	4710	4711	4720	4710 Tiroir/Drawer	4711 Tiroir/Drawer	4720 Tiroir/Drawer
H / H Min.	3" / 76mm	3" / 76mm	3" / 76mm	3" / 76mm	3" / 76mm	3" / 76mm
L / W Min.	3" / 76mm	3" / 76mm	3" / 76mm	3" / 76mm	3" / 76mm	3" / 76mm

Couleurs disponibles Available Colours

R6

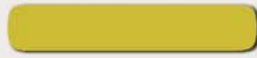

122 OLIVE



80 ROUGE / RED



81 RUBIS / RUBY



83 ACAJOU / MAHOGANY



34 CRÈME / CREAM



41 BEIGE



31 EBENE DE MACASSAR
EBONY MACASSAR



60 CHOCOLAT / CHOCOLATE



906 ANTHRACITE / ANTHRACIT



84 AUBERGINE / EGGPLANT



90 NOIR / BLACK



NOTE :
Les couleurs représentées sont des reproductions, consulter l'échantillon réel avant d'effectuer votre choix final.

The colors represented are reproductions, please view actual sample before making your selection.

Dos comme devant non disponible.
Matching back not available.



4069



4070



Tiroir/Drawer
4069



Tiroir/Drawer
4070



4075



4076



Tiroir/Drawer
4075



Tiroir/Drawer
4076

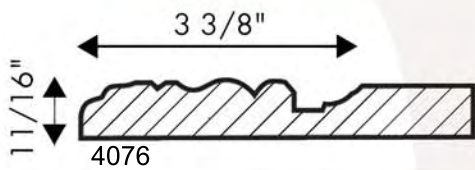

4076

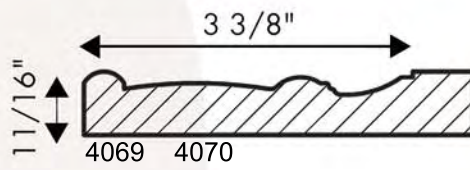

4069 4070

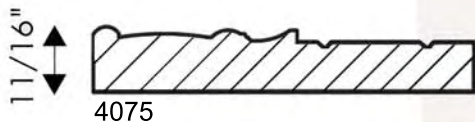

4075



Tiroir/Drawer
4069 P
4070 P
4075 P
4076 P

Modèle/Model	4069	4070	4075	4076	4070/4075 Tiroir/Drawer	4076/4069 Tiroir/Drawer
H / H Min.	7 3/8" / 188mm	6 1/4" / 159mm	6 1/4" / 159mm	7 3/8" / 188mm	4 1/4" / 108mm	5 3/8" / 136mm
L / W Min.	7 3/8" / 188mm	6 1/4" / 159mm	6 1/4" / 159mm	7 3/8" / 188mm	4 1/4" / 108mm	5 3/8" / 136mm

Portes de Polymère Polymer Doors

4200

Panneau double et triple disponible
Double & triple panel available



4200



4210



4220



4230



Tiroir/Drawer 4200



Tiroir/Drawer 4200 P

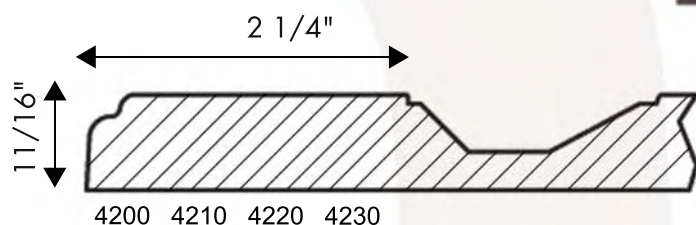

Modèle/Model	4200	4210	4220	4230	4200 Tiroir/Drawer
H / H Min.	8 1/4" / 209mm	9 5/8" / 244mm	8 5/8" / 219mm	9 5/8" / 244mm	5 1/8" / 130mm
L / W Min.	8 1/4" / 209mm	8 1/4" / 209mm	8 1/4" / 209mm	8 1/4" / 209mm	8 1/4" / 209mm

Panneau double et triple disponible
Double & triple panel available



4500



4510



4520



4530



Tiroir/Drawer 4500



Tiroir/Drawer 4500 P

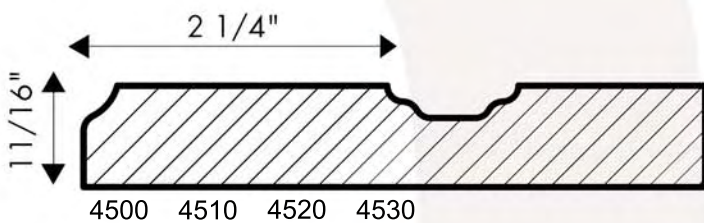

Modèle/Model	4500	4510	4520	4530	4500 Tiroir/Drawer
H / H Min.	7 3/4" / 196mm	9" / 229mm	8 1/8" / 206mm	9 1/2" / 241mm	5" / 127mm
L / W Min.	7 3/4" / 196mm	7 3/4" / 196mm	7 3/4" / 196mm	7 3/4" / 196mm	7 3/4" / 196mm

Portes de Polymère Polymer Doors

4600

Panneau double et triple disponible
Double & triple panel available



4600



4610



4620



4630



Tiroir/Drawer 4600



Tiroir/Drawer 4600 P

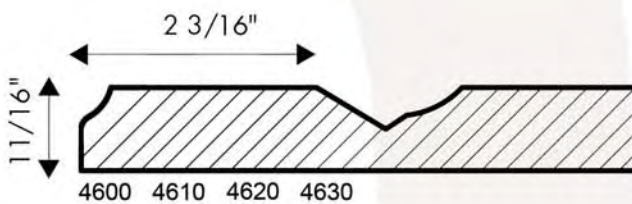

Modèle/Model	4600	4610	4620	4630	4600 Tiroir/Drawer
H / H Min.	7 1/8" / 180mm	8 3/8" / 213mm	7 3/8" / 187mm	9 1/8" / 232mm	5 1/8" / 130mm
L / W Min.	7 1/8" / 180mm	7 1/8" / 180mm	7 1/8" / 180mm	7 1/8" / 180mm	7 1/8" / 180mm



4700

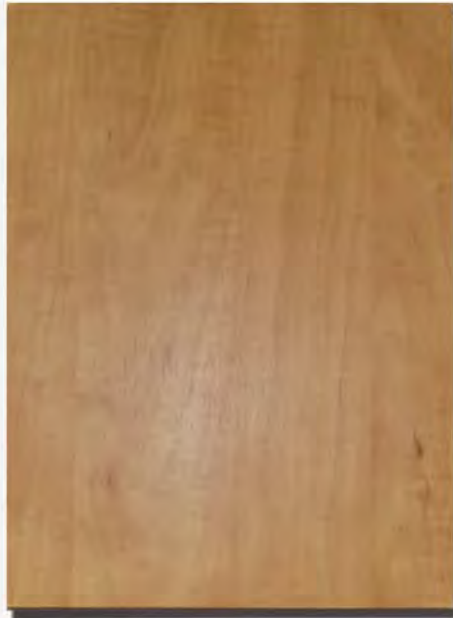

4706



4709



Tiroir/Drawer 4700



Tiroir/Drawer 4706



Tiroir/Drawer 4709

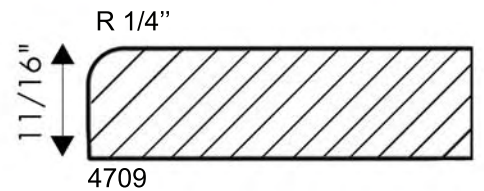
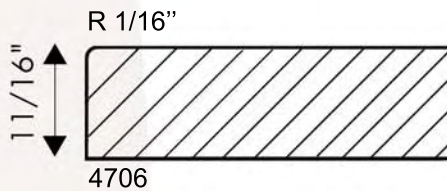
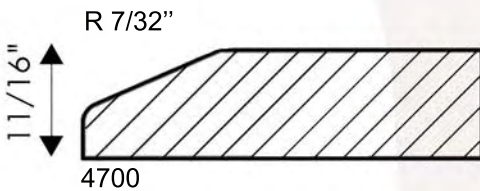

Modèle/Model	4700	4706	4709	4700 Tiroir/Drawer	4706 Tiroir/Drawer	4709 Tiroir/Drawer
H / H Min.	3" / 76mm	3" / 76mm	3" / 76mm	3" / 76mm	3" / 76mm	3" / 76mm
L / W Min.	3" / 76mm	3" / 76mm	3" / 76mm	3" / 76mm	3" / 76mm	3" / 76mm



4710



4711



4720



Tiroir/Drawer 4710



Tiroir/Drawer 4711



Tiroir/Drawer 4720

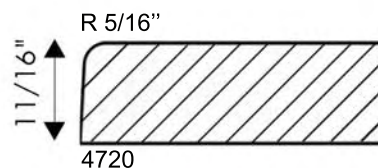
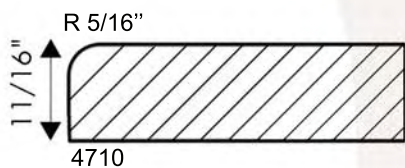

Modèle/Model	4710	4711	4720	4710 Tiroir/Drawer	4711 Tiroir/Drawer	4720 Tiroir/Drawer
H / H Min.	3" / 76mm	3" / 76mm	3" / 76mm	3" / 76mm	3" / 76mm	3" / 76mm
L / W Min.	3" / 76mm	3" / 76mm	3" / 76mm	3" / 76mm	3" / 76mm	3" / 76mm

Panneau double et triple disponible
Double & triple panel available



4800



4821



4830

Tiroir/Drawer 4800 P



Tiroir/Drawer 4800

Tiroir/Drawer 4821 P



Tiroir/Drawer 4821

Tiroir/Drawer 4830 P



Tiroir/Drawer 4830

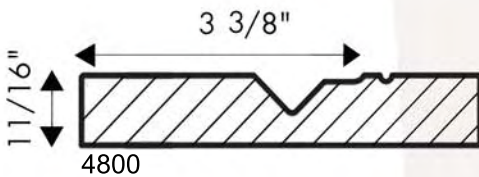

4800

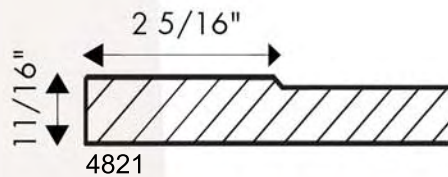

4821

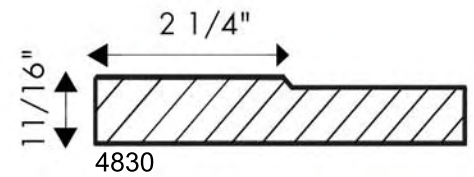

4830

Modèle/Model	4800	4821	4830	4800 Tiroir/Drawer	4821 Tiroir/Drawer	4830 Tiroir/Drawer
H / H Min.	7" / 179mm	6 3/4" / 171mm	7 1/4" / 185mm	4 1/4" / 108mm	3 1/2" / 89mm	3 1/2" / 89mm
L / W Min.	7" / 179mm	5 3/4" / 146mm	5 3/4" / 146mm	7" / 179mm	5 3/4" / 146mm	5 3/4" / 146mm

Panneau double et triple disponible
Double & triple panel available



4841



4850



4855

Tiroir/Drawer 4841 P



Tiroir/Drawer 4841

Tiroir/Drawer 4850 P



Tiroir/Drawer 4850

Tiroir/Drawer 4855 P



Tiroir/Drawer 4855

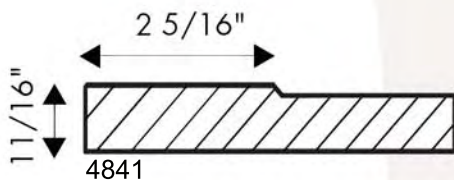

4841

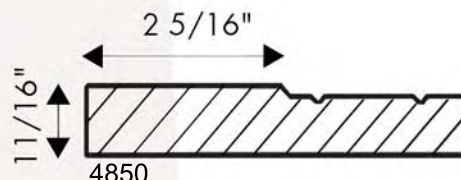

4850

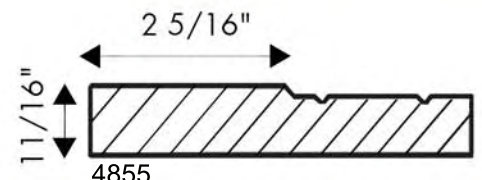

4855

Modèle/Model	4841	4850	4855	4841 Tiroir/Drawer	4850 Tiroir/Drawer	4855 Tiroir/Drawer
H / H Min.	5 3/4" / 146mm	5 3/4" / 146mm	5 3/4" / 146mm	3 1/2" / 89mm	3 1/2" / 89mm	3 1/2" / 89mm
L / W Min.	5 3/4" / 146mm	5 3/4" / 146mm	5 3/4" / 146mm	5 3/4" / 146mm	5 3/4" / 146mm	5 3/4" / 146mm

Panneau double et triple disponible
Double & triple panel available



4856



4857

Tiroir/Drawer 4856 P



Tiroir/Drawer 4856

Tiroir/Drawer 4857 P



Tiroir/Drawer 4857

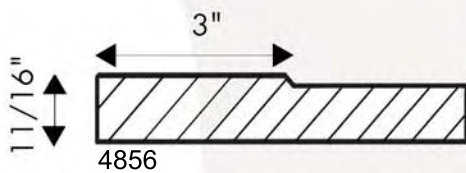

4856

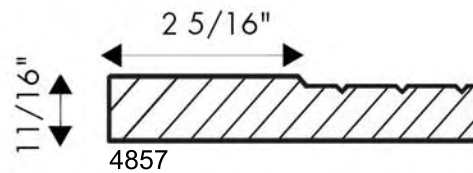

4857

Modèle/Model	4856	4857	4856 Tiroir/Drawer	4857 Tiroir/Drawer
H / H Min.	6 1/2" / 165mm	6" / 153mm	5" / 127mm	3 1/2" / 89mm
L / W Min.	6 1/2" / 165mm	6" / 153mm	6 1/2" / 165mm	6" / 152mm

Accessoires / Accessories

Doigt de dame / Fluted filler

Modèles / Models

480 / 481 / 482

Toujours 3 rainures, surcharge pour rainure additionnelle, l'espace entre les rainures dépend de la largeur du doigt de dame.
Always 3 grooves, charge for additional groove, the space between grooves depends on the width of the Fluted filler.

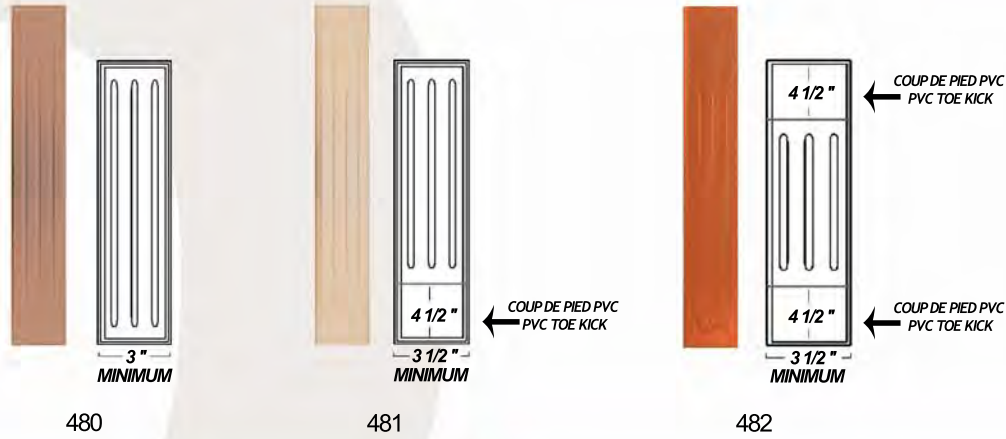

Cache-néon / Light valance

461 / 462 Cache-néon 3" x 8', usiné 1 côté
Light valance, shaped 1 side



463 Cache-néon / Light valance 3/4" x 2 3/8" x 8'
464 Cache-néon / Light valance 3/4" x 3" x 8'

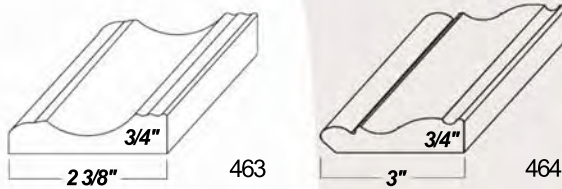

Décor tambour / Decorative tambour

443

444

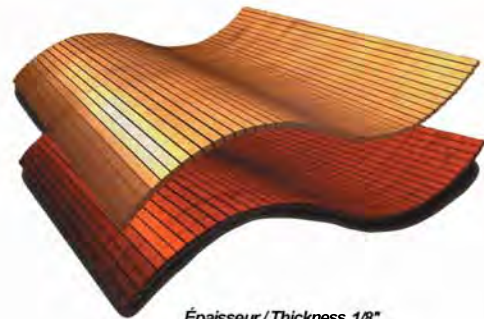

Épaisseur / Thickness 1/8"

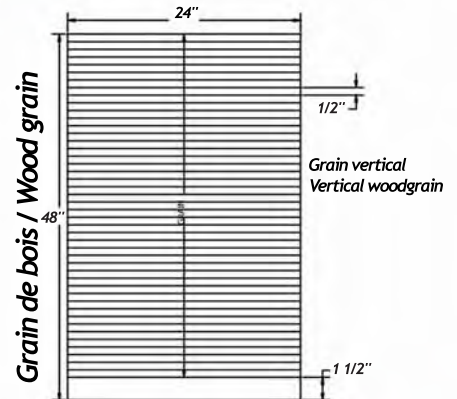

Accessoires / Accessories

Valences / Valances

490

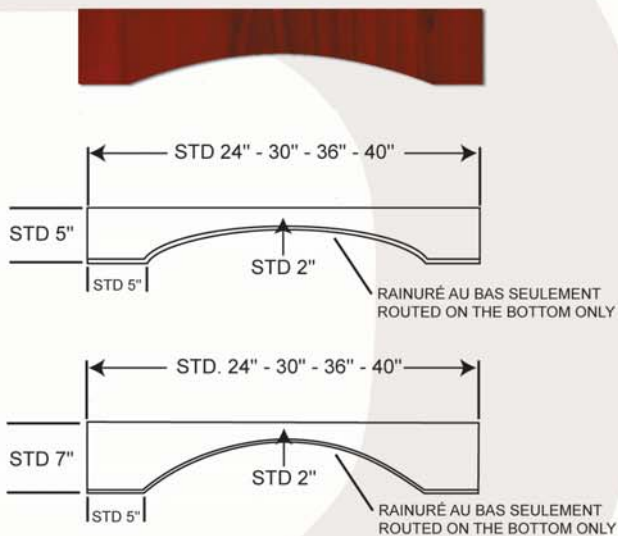

491

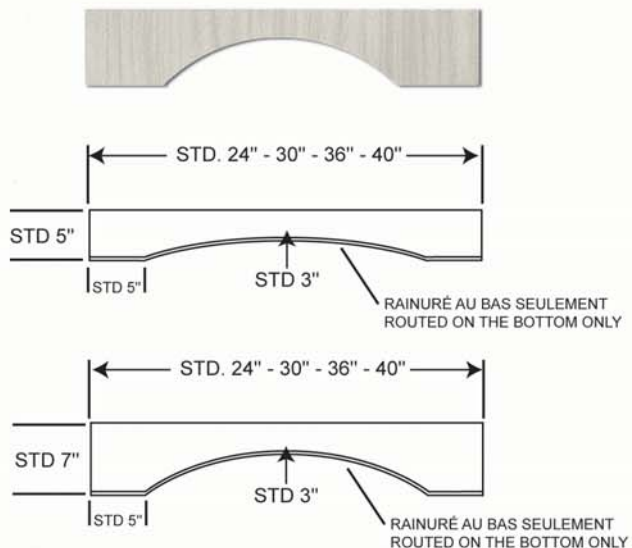

492

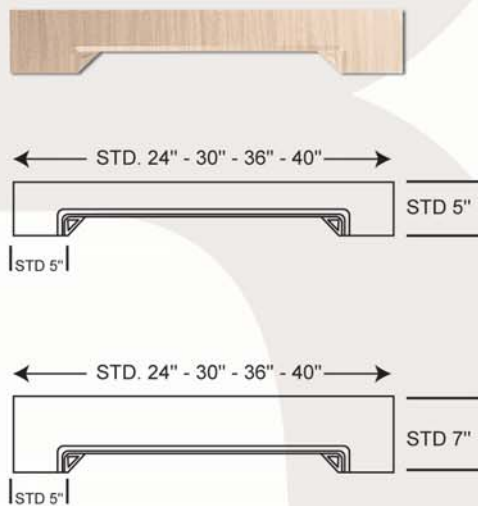

Accessoires / Accessories

Panneau pour micro-ondes et four Trim kit for microwave and oven

Supports à bouteilles / Wine racks

4806



SUPPORT À BOUTEILLES AVEC 4 TROUS.
WINE RACK WITH 4 ROUNDS HOLES.

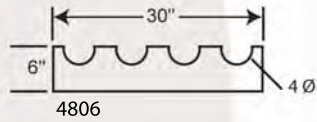

4812



SUPPORT À BOUTEILLES AVEC 4 TROUS.
WINE RACK WITH 4 ROUNDS HOLES.

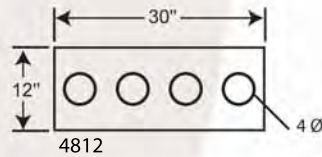

4818-4821-4824



SUPPORT À BOUTEILLES AVEC 8 TROUS.
WINE RACK WITH 8 ROUNDS HOLES.

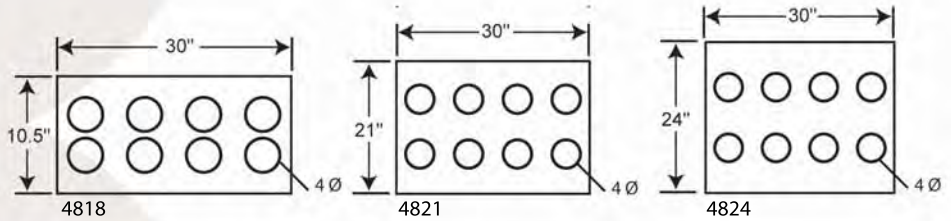

4912-4918



SUPPORT À BOUTEILLE AVEC 3 CARREAUX.
WINE RACK WITH 3 SQUARES.

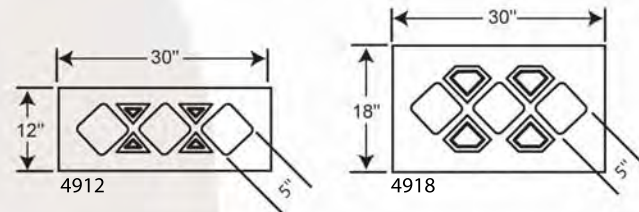

427

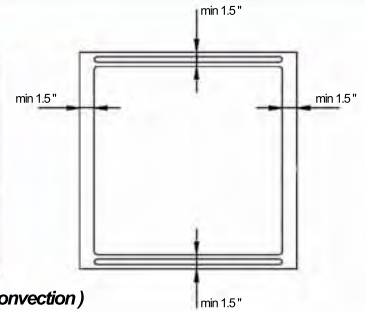

(non recommandé pour four à convection)
(Not recommended for convection oven)

Trou de ventilation en option
Optional air vent

Accessoires / Accessories

Mouleurs décoratives / Decorative mouldings

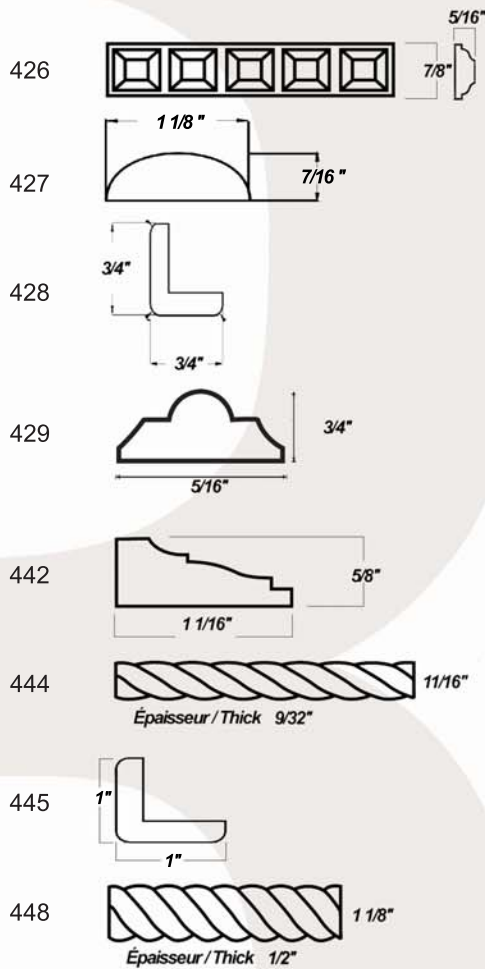

OPTION :

Possibilité d'insérer une moulure décorative / Possibility to insert a decorative moulding

* 426 / 427 / 444

** 426 / 429 / 444

Mouleurs de tête / Crown mouldings

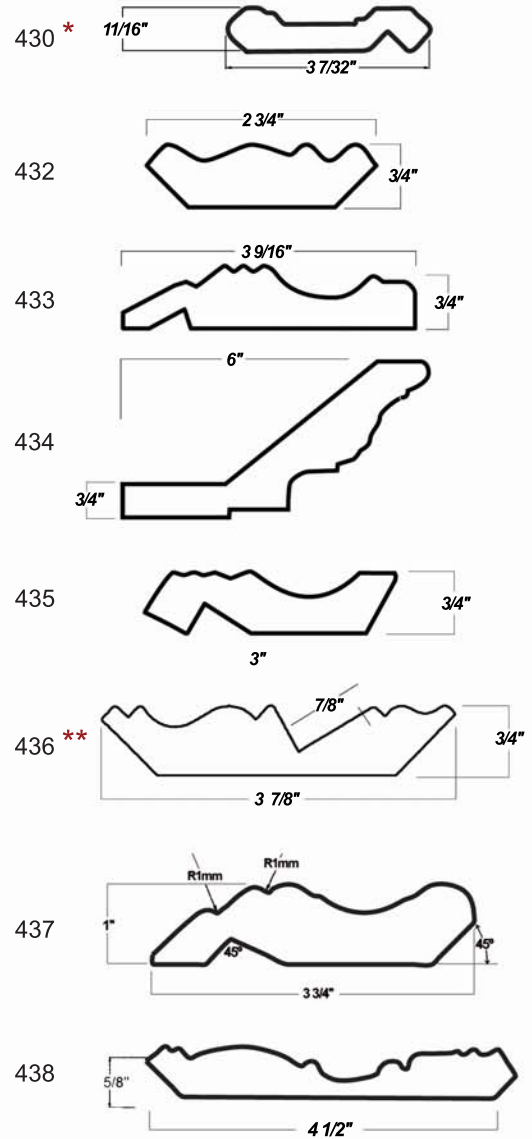

496

Protecteur de chaleur
Heat Protector

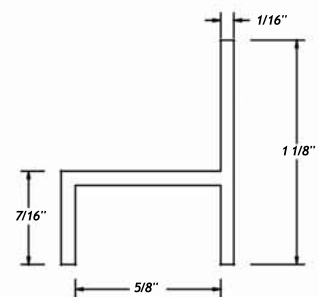

Accessoires / Accessories

Arabesques



4201
5 1/2" x 15/16" chaque



4202
9" x 2 1/2"



4203
9" x 2"



4204
12" x 2 1/4"



4205
8 1/4" x 1 3/4"



4206
6" x 2 1/2"



4207
2 1/2"



4208
3" x 2 1/4"



4209
3 1/2" x 3 3/4" x 1/2"



4210
3 1/2" x 8 1/4" x 1/2"



4212
4 5/8" x 15 3/4" x 3/8"



4213
3 7/8" x 16" x 3/4"



4211
16 3/4" x 3 1/2" x 3/4"

Les arabesques sont vendues pressées sur valence ou panneau et non séparément.
Arabesques are sold pressed on valance or panel, not sold separately.



Richelieu donne la garantie expresse suivante pour chacun de ses produits de polymère distribués et vendus par un distributeur autorisé.

Richelieu garantit que ce produit de polymère est exempt, sous réserve d'une utilisation normale et d'un entretien recommandé, de tous défauts de fabrication, sujet néanmoins aux termes et conditions suivantes:

1. CONDITIONS GÉNÉRALES

Si un défaut est décelé dans un produit de polymère Richelieu, à l'intérieur d'une période de dix (10) ans de la date d'achat, les réparations et/ou le remplacement des pièces seront effectués à la discrétion de Richelieu lorsqu'elle reconnaîtra que les dits défauts résultent d'un défaut de fabrication.

2. EXCLUSIONS

Cette garantie ne s'applique pas:

- a) Lorsque suite à une mauvaise utilisation, un emploi abusif, une négligence, un accident, une utilisation ou une installation inadéquate et/ou un manque de précaution, il en résulte une défectuosité et/ou qu'une réparation est nécessaire.
- b) Lorsqu'un produit de polymère Richelieu est manipulé, modifié ou réparé par toute personne autre que Richelieu ou un de ses représentants autorisés à effectuer les réparations.
- c) A la détérioration d'un élément extérieur (surface) du produit résultant d'une usure normale.
- d) Dans les limites permises par la loi à la perte de temps ou d'utilisation du produits de polymère Richelieu pour les coûts d'installation et de transports relatifs à l'application de la présente garantie, ou à tout autre dommage et inconvénients indirect ou incident.
- e) *Si le produit est installé près d'une source de chaleur, d'un appareil électroménager mal isolé, ou si le produit est installé dans une pièce où la température ambiante est excessive, en combinaison avec un taux d'humidité supérieur à 50%. (Le degré d'humidité doit se situer entre 30% et 50% dépendant de la température extérieure laquelle varie d'une saison à l'autre).
- f) La couverture contre le jaunissement prématuré est limitée à cinq (5) ans

*Important : Si le produit est installé dans une maison neuve, la température devra être ajustée en référence au paragraphe e) immédiatement.

3. EXÉCUTION DE GARANTIE

S'il arrive que le produit ait un défaut durant la période couverte par la garantie, l'acheteur pourra obtenir les services stipulés à la présente garantie en retournant les produits et une preuve d'achat au distributeur Richelieu autorisé où l'achat a été effectué.

4. EXCLUSION DE TOUTES AUTRES GARANTIES EXPRESSES

Cette garantie constitue la seule et unique garantie donnée par Richelieu pour les produits de polymère et aucun distributeur Richelieu n'est autorisé à prolonger ou élargir la présente garantie au nom de Richelieu.

Richelieu gives the following express warranty for each of its polymer products sold by an authorized Richelieu distributor.

Richelieu guaranties that the Richelieu polymer product is exempt, under normal use and maintenance, from any manufacturing defect, subject to the following terms and conditions.

1. STANDARDS

If any fault should be found in a Richelieu polymer product within the warranty period of ten (10) years from the date of purchase, necessary repairs and/or replacement shall be made under Richelieu discretion when the latter acknowledges that such defects are due to faulty workmanship.

2. LIMITATIONS

This warranty shall not apply to:

- a) Any defects or repairs required as a result of misuse, abusive operation, negligence, accident, improper use or installation and / or lack of precaution.
- b) Any Richelieu polymer product tempered by adjustment, altered or repaired by any party other than Richelieu, or an authorised servicing agent.
- c) Any defects to the surface caused by normal wear and tear.
- d) To the extent the law permits, loss of time or enjoyment of a polymer product, for installation nor for transportation costs resulting from the application of this warranty, or any other indirect or consequential damage or inconvenience.
- e) *A product which is installed close to a heating system, an appliance not properly isolated, or if the product is installed in a room where the temperature is excessive with a combined with a level of humidity of 50%. (The degree of humidity should be situated between 30% to 50% depending on the outside temperature which varies from one season to the other.)
- f) Coverage against pre-mature yellowing is limited to five (5) years

*Important: If the product is installed in a new home, the temperature must be adjusted, as per the above mentioned paragraph e) immediately.

3. WARRANTY PROCEDURE

Should your Richelieu polymer product reveal any defects in material during the warranty period, warranty service may be obtained upon delivery of the product together with proof of purchase to the Richelieu distributor from whom it was purchased.

4. EXCLUSION OF ALL OTHER EXPRESS WARRANTIES

This warranty constitutes the entire express warranty given by Richelieu for the polymer product and no Richelieu distributor is authorised to extend or enlarge this warranty on behalf of Richelieu.

Couleurs disponibles Available Colours

MDF / MDF **R1**
MELAMINE / MDF **R2**
R3



R4



R5



R6



NOTE :
Les couleurs représentées sont des reproductions, consulter l'échantillon réel avant d'effectuer votre choix final.

The colors represented are reproductions, please view actual sample before making your selection.

* **Dos comme devant disponible.**
* **Matching back available.**

Richelieu